

USER MANUAL

Body Worn Camera



About this Guide

The content in this document is for information purpose and is subject to change without prior notice. We have made every effort to ensure that this User Guide is accurate and complete.

However, no liability is assumed for any errors or omissions that may have occurred.

The manufacturer reserves the right to change the technical specification and accessories without prior notice.

Caution

Do not expose battery being placed in high temperature environment. If battery leaks or bulges, stop to use.

Risk of explosion if battery is placed by an incorrect type.

Dispose of used batteries according to the instructions.

Never replace the battery on your own. Doing so may cause the damage or explosion. Please have the dealer do it for you.

Do not put the LCD display or lens under the sunshine.

Note

A specific emission frequency may influence the image quality.

Please try a few times of video-taking test before you formally use this product in order to be familiar with this product.

Always full charge the battery before use.

Never dismantle, crush, or pierce the product, or allow the product to short-circuit. Please persuade for professional assistance if the product doesn't work properly.

Before you start using this product, it is assumed that you agree to the above statement.

TABLE OF CONTENTS

About this Guide

Caution

Note

- 1. Introduction**
- 2. Box Contents**
- 3. Product Overview**
- 4. Main Menu Optional Detail**
- 5. Operation**
- 6. Camera setting through Camera Manager**

This camera is new generation video recorder of High Efficiency video coding (HEVC, H.265) and low power consumption. If you record videos by using H.265 coding format, it is suggested to download Media Player Codec Pack (check below link) to assist to play back H.265 videos on windows Media Player.

<https://www.mediaplayercodecpack.com/>

1. Introduction

Thank you for purchasing this product. This camera is specially designed for video recording, audio recording and photo shooting. Please read the user manual before you start to use it.

Important information: before you start to use this device, please connect it to computer through auxiliary USB cable, then camera will require password in the LCD screen. Please **press OK button for six times** to get access to camera storage, then Copy **BodyCam PC software** from camera folder to your computer for camera setting purpose in the future. Without the software, you can also change camera setting on camera menu (Page 8). **BodyCam PC software** will be deleted if you format the camera storage. Please contact vendor if it is lost.

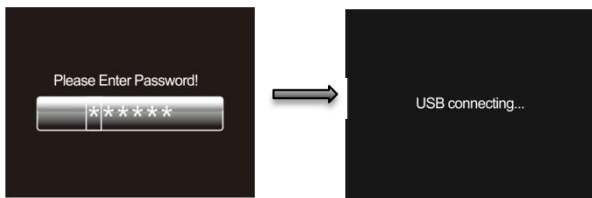

2. Box contents

- Body Camera
- USB Cable
- Wall Charger
- Rotatable Epaulette Clip
- Rotatable Crocodile Clip
- User Manual

3. Product Overview

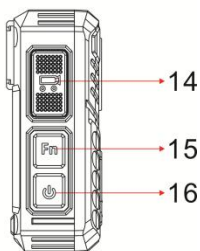
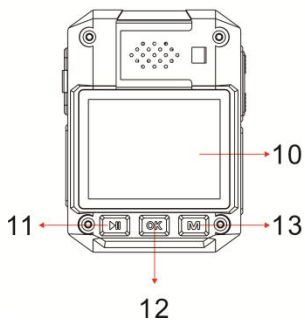
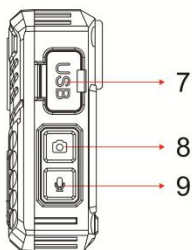
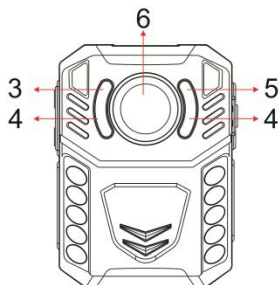

Item	Description
1. Status Indicator LED	<p>Still Green: camera is in standby mode (Power on but not recording)</p> <p>Still Red: camera is on pre-recording mode</p> <p>Flashing Red: camera is recording video</p> <p>Flashing Red and Green: camera is recording audio only</p> <p>Flashing Red Once: camera is taking photo</p>
2. Charging Indicator LED	<p>Still Blue: Charging Status</p> <p>Still White: Camera is fully charged</p>
3. Light Sensor	<p>Detect changes of light and turn on/off IR for low-light recording automatically</p>
4. Infrared LED	<p>Providing infrared light compensation in low light conditions, to help camera record good quality video with clear face view up to 10 meters</p>
5. White Light	<p>Hold Fn button to turn on/off white light</p>
6. Lens	<p>Capture high resolution images/videos</p>
7. USB Port & Reset Button	<p>USB port is for power charging or data transmission; Reset camera when camera has operation minor</p>
8. Snapshot Button	<p>Press to take photo in standby mode or in video recording mode</p>
9. Audio Button	<p>Press to start/stop audio recording</p>
10. LCD Screen	<p>View camera status and playback recorded files</p>
11. Scroll Up Button	<p>a) In Menu or Playback mode, press to scroll up previous page or file</p> <p>b) In standby or video recording or playback photo mode, hold to zoom out</p> <p>c) In playback mode, press to rewind video</p>

<p>12. OK Button</p>	<p>a) In menu set-up or playback file type (video, photo and audio) selection, press to make a selection</p> <p>b) In standby mode, press to review files</p> <p>c) In playback mode, press to pause/resume video or audio playback</p> <p>d) In video or audio recording mode, hold to lock the file</p> <p>e) In video or audio recording mode, press to mark the important file</p>
<p>13. Menu & Scroll Down Button</p>	<p>a) In standby mode, press to enter menu set-up</p> <p>b) In Menu or Playback mode, press to scroll down next page or file</p> <p>c) In standby or video recording or playback photo mode, hold to zoom in</p> <p>d) In playback mode, press to fast forward video</p>
<p>14. Video Recording Button</p>	<p>a) In power-on mode, press to start/stop recording</p> <p>b) In audio recording, press to switch to video recording and keep the audio file</p> <p>c) In power-off mode, hold for 3 seconds to power on camera and execute video recording function.</p>
<p>15. Fn Button</p>	<p>a) Press to turn on/off IR light</p> <p>b) Hold to turn on/off white light.</p>
<p>16. Power Button</p>	<p>a) Hold 3 seconds to power on/off camera</p> <p>b) In power-on mode, press to turn on/off LCD .</p> <p>c) Press to exit to previous interface when navigating setting or playing back files</p>

LCD Interface:

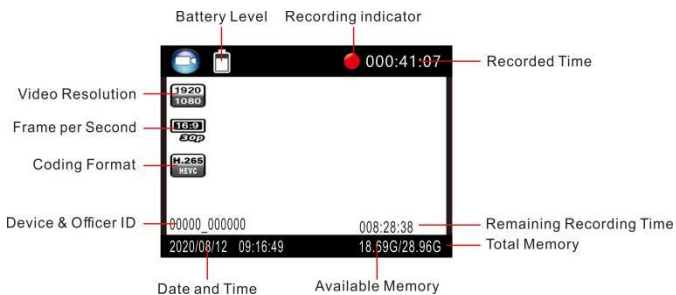

4. Main Menu Optional Detail

To enter the setting menu:

1. Press Menu button **M** and then enter the password.
2. Enter the password by the following commands:
 - Press Scroll Up button to change the character to the previous letter or number.
 - Press Menu button to change the character to the next letter or number.
 - Press OK button to confirm and move to the next character

PS: The default password is 000000.

3. After selecting the last character, press OK button to enter the setting menu.

To navigate the settings menu:

- Press Scroll Down button to select next setting or option.
- Press Scroll Up button to select the previous setting or option.
- Press OK button to move to confirm your selection or enter the sub-menu.
- Press Power button to return to the previous menu.

Following is a list of the available settings and options.

Setting	Description	Options
Video Resolution	The video resolution	2560×1440 30P 2304×1296 30P 1920×1080 30P 1280×720 30P 848×480 30P

Photo Resolution	The photo resolution	5M (3008×1692 16:9) 12M (4608×2592 16:9) 20M (5984×3366 16:9) 25M (6656×3744 16:9) 30M (7296×4104 16:9)
Burst	The number of images captured in a row when you take a photo.	Off, 2, 3, 5, 6, 8, 10, 15, 20
Dewarp	When on, video distortion correction will be corrected, with more power consumption.	Off, On
Self Timer	The time camera waits until taking a photo after you press Snapshot button.	Off, 5 secs, 10 secs, 20 secs, 30 secs, 1 min
Quality	The quality of the video.	S. Fine, Fine, Normal
Pre-record	When on, a certain time (depend on video resolution) will be combined into the recorded video before record button is pressed to start recording; When off, video start until the Record button is pressed to start recording.	Off, On
Post Record	The amount of the time the camera waits to stop recording video after you press the Record button.	Off, 5 sec, 1 minute, 10 mins, 20 mins, 35 mins
CarDV Mode	When on, camera will power up automatically and start video recording when it is charged. Camera will power off as it normally does when it is disconnected from the power source.	Off, On

Loop Recording	When on, camera will overwrite the oldest video file with the most current video file once its memory is full. This setting can be selected only when car DVR mode is on.	Off, On
Split Time	While recording video, the camera will automatically split its recording into files of this length.	1 min, 3 mins, 5 mins, 10 mins, 15 mins, 20 mins, 30 mins, 45 mins
Slideshow	When on, viewing photo file will start a slideshow where each photo will be shown for around 5 seconds.	Off, On
Infrared	When set to manual, you will need to press Fn button to turn IR LEDs on/off. When set to Auto, these lights will activate automatically based on the light sensor's reading.	Manual, Auto
Motion Detect	When on, camera will start recording when front movement is detected by the lens.	Off, On
Record Warning	When on, you will hear a voice confirmation when you start recording. When off, voice confirmation is disabled.	Off, On
Video Mute	When on, there is no sound in the video. When off, there is sound in the video	Off, On
Language	The language of the text in camera interface	English, 简体中文, Русский, Polski, 한국, French, 日本語, Portuguese, Español, Türk
Screen Saver	The amount of the time the camera can be idle before deactivating the display to conserve power.	Off, 30 secs, 1 min, 3 mins, 5 mins
LCD Brightness	Screen lighting to view	High, Medium, Low

Auto Power off	The amount of the time the camera can be idle before powering off.	Off, 30 secs, 1 min, 3 mins, 5 mins
LED Light	When on, indicator LED will tell the status of the camera; When off, camera is entering covert mode	On, Off
White Led	White Led light to offer light source	Off, On
Key Tone	When on, camera will play a tone each time you press a button. When off, tone is disabled.	On, Off
Volume	The volume of camera speaker. This affects the loudness of video playback, audio playback, the key tone, record warning, and any other sounds played by camera. This doesn't affect the volume of the recorded video or audio files themselves.	0-12 Default 12
Coding Format	The coding format of video files	H.264, H.265
Time Setup	Adjust time to real location	yyyy/mm/ddhh/mm
ID Setting	User can set Device ID and Officer ID	Alphanumeric characters
Password	If password is on, user needs to enter password to get access to setting and connection to PC	On, Off
Change User Password	Password can be set or changed	Alphanumeric characters
Default Setting	Use this to return camera to its original settings. This does not erase the memory	O (Yes), X (No)
FW Name	Firmware version	



5. Operation

5.1 Power on/off

Hold Power button  for 3 seconds to start up and enter standby mode; In any mode with holding Power button for 3 seconds, camera will shut down.

PS: in standby / video recording / audio recording mode, press power button , screen saver can be on/off.

5.2 Audio recording



In standby mode, press audio Recording Button  for audio recording. Camera will beep and LED indicator on the top will flash red and green. Press again audio Recording Button  to stop audio recording and save the file.

In audio recording mode, press OK button  to mark the important file, and the yellow star icon will appear on the right side of the screen.

5.3 Photo shooting

In standby mode, press photo button  to take photos.

5.4 Video recording

In standby mode, press video Recording Button  to start video recording. Camera will beep and LED indicator on the top will flash red. Press again video Recording Button  to stop video recording and save the file.

In video recording mode, press OK button  to mark the important file, and the yellow star icon will appear on the right side of the screen.

5.5 One-button video recording

In power-off mode, hold video Recording Button  for three seconds for powering on the camera and start video recording immediately.

5.6 PIV (picture in video)



In video recording mode, press photo button  to capture photo.

5.7 Zoom

In standby or video recording mode, hold Scroll Up button and scroll down button to zoom in and out the image.

5.8 IR night vision

Under dark circumstances, infrared LED will help to record clear image or video.

In standby mode, PRESS Menu button  to navigate. Find option **【Infrared】**, PRESS OK button  to enter sub-menu: Manual & Auto, press OK button  to select.

1) Auto infrared mode:

In low light situations (1 Lux), 4 IR LEDs will be turned on automatically, camera switches on infrared filter lens, video image turn black and white. Otherwise, when circumstance brightness grew up, IR LED turns off, and image becomes colorful again.



2) Manual infrared mode:



When night vision is needed, press infrared light button  to switch to Infrared mode, IR LEDs will be turned on, black and white image. press this button again to turn off IR LEDs, image becomes colorful.

5.9 White LED

In standby or video recording mode, hold Fn button  to turn on/off white LED.

5.10 Playback

In standby mode, press OK button to enter playback mode. There are Video, Photo and Audio options. Press Photo button  to select, and press OK button  to confirm the selection.



1) In video file playback mode, PRESS OK button  to pause/resume playback; PRESS scroll-Up button to rewind, PRESS Scroll-down button to fast forward, then PRESS OK button  to play normally. You can fast forward or rewind 2x, 4x, 8x, 16x, 32x, 64x.

2) In photo file playback mode, hold scroll-Up button and Scroll-down button to zoom in and out the image. Adjustable is X1.0~X10.0. In the zoom in and out image, press scroll-Up button and Scroll-down button to move the image to right or left side.

5.11 Reset



In any case the camera is frozen, use a pin to reset and restart the camera. Reset button is inside USB port.

5.12 Device ID/ User ID

In standby mode, PRESS Menu button  to enter settings. Find [ID setting], PRESS OK button  to select, then the Device & Person SN interface will show up, 5 characters for device ID and 6 characters for person ID.

PRESS scroll-Up button or Scroll-down button to choose a character, then PRESS OK  button to select.

5.13 Time Setting

In standby mode, PRESS Menu button  to enter settings. Find Time bar, for example, 2008/02/02 07:40. PRESS OK button  and enter the password, then users can change the date and time.

Press scroll-Up button or Scroll-down button to choose a character, then PRESS OK button  to select.

5.14 USB Driver video/picture/audio files can only be deleted on your PC/laptop.

After being connected to PC, password interface shows up, please enter the password (default password is 000000) Press the (ok) button 6 times, the camera will be recognized by the computer as Extra drive. User can go to camera folder and delete those files not needed.

5.15 Charging

When camera battery is low, the battery icon will flash in the display, and you will hear a alert tone. When this happens, charge the camera. While camera is charging, indicator light is still blue and will turn still white after camera is fully charged. It will take approximately 4 hours to fully charge the camera.

Charging methods:

Use a USB cable to connect camera's USB port to a USB port on your computer (powered on) or USB power adapter (connect to a power outlet)

6. Camera setting through Camera Manager

Camera setting can be changed within the menu or by **Camera Manager** (from **BodyCam PC Software**). The software is stored in camera storage. Please check page 3 to get access to it.

本地磁盘 (E:) > BodyCam PC Software-v0.5 > Camera Manager 4.1

名称	修改日期
Camera Manager 4.1.exe	2021/11/2 16:57
h22_4g_pc.dll	2020/9/28 14:53
h22_4g_pc.h	2021/7/27 14:51
h22_4g_pc.lib	2020/7/29 10:34
Language.ini	2021/9/18 9:00
libusb0.dll	2016/10/18 9:26
mfc140u.dll	2016/2/15 16:43
mfc140ud.dll	2016/7/21 23:05
ucrtbased.dll	2016/8/14 5:32
vcruntime140.dll	2017/2/2 15:49

1, Open Camera Manager and enter password, connect and login.
(Default password is 000000)

Camera Manager 4.1 ×

Body Worn Camera

User Type :

Password :

Language :

2, Click “Get” to show up camera original settings. Choose target setting and click “Set”, then setting is changed.

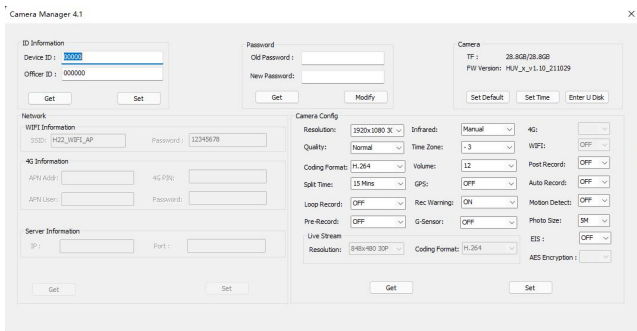

3, Click “Enter U Disk” (upper right corner) to make camera to be recognized by PC as a folder. You can check all files from the camera folder.

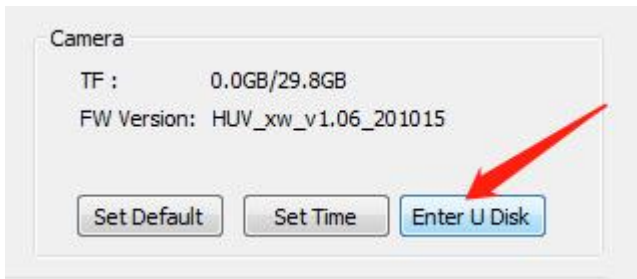

IMPORTANT INFORMATION

The clips and attachment studs rotate 360 degrees -

The crocodile clip, epaulette clip, chest harness and shoulder harness attachment studs ALL turn 360 degrees. Slot the clip into the back of the camera then turn the clip vertically. Or you can slot the clips into the back of the body camera first, then attach the body camera to the chest or shoulder harness, then turn the body camera vertically.

Reset device-

To reset the device, use a small needle to jab the reset button. The reset button is located next to the USB port.

Delete files -

You can only delete the recorded files from a computer. This is to stop people from getting rid of the evidence straight from the device itself. To delete the files from your computer, right click, and then delete them.

Product warranty -

We offer a 12-month warranty on the body camera. This warranty covers faults that were caused by the manufacturer. If the fault was caused by the customer, then the warranty will be void.

USB cable -

Please only use the USB cable provided in the product box. Using other USB cables might cause damage to the body camera.

Attention -

Please charge camera fully after camera is left without working for long time.

Please keep camera bottom away from water to avoid short circuit or oxidation.

Please don't disassemble camera without authorized instruction.